

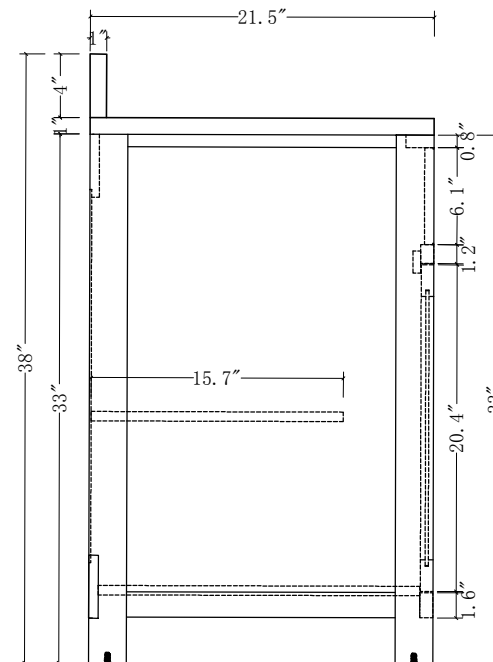

MODEL: MADISON30

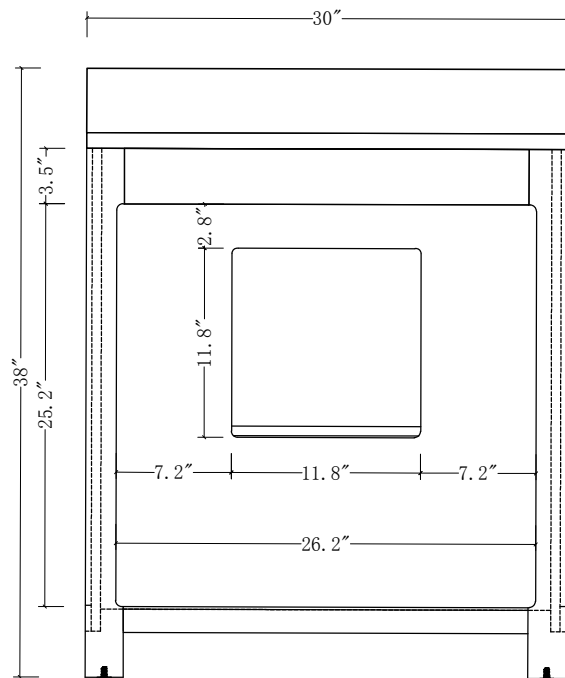

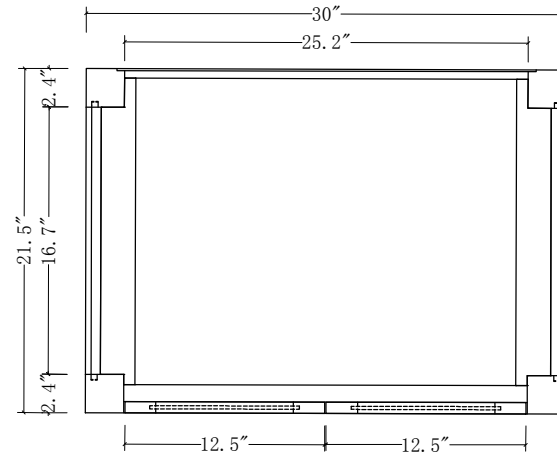
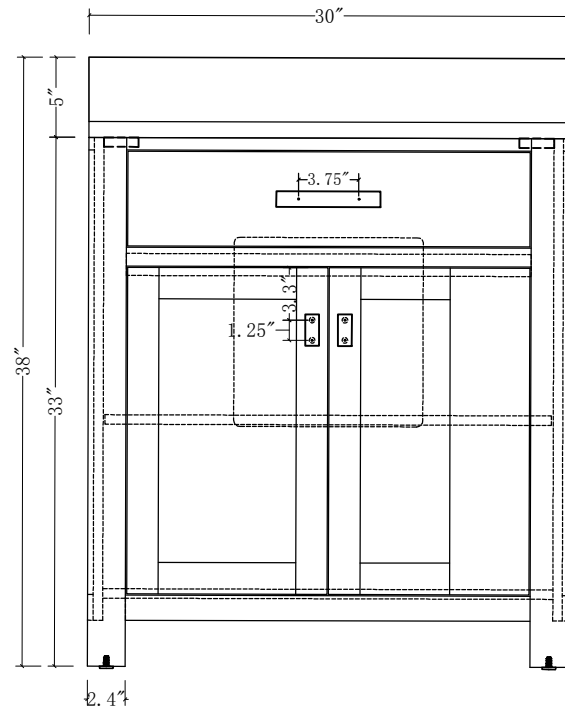

MODEL: MADISON30

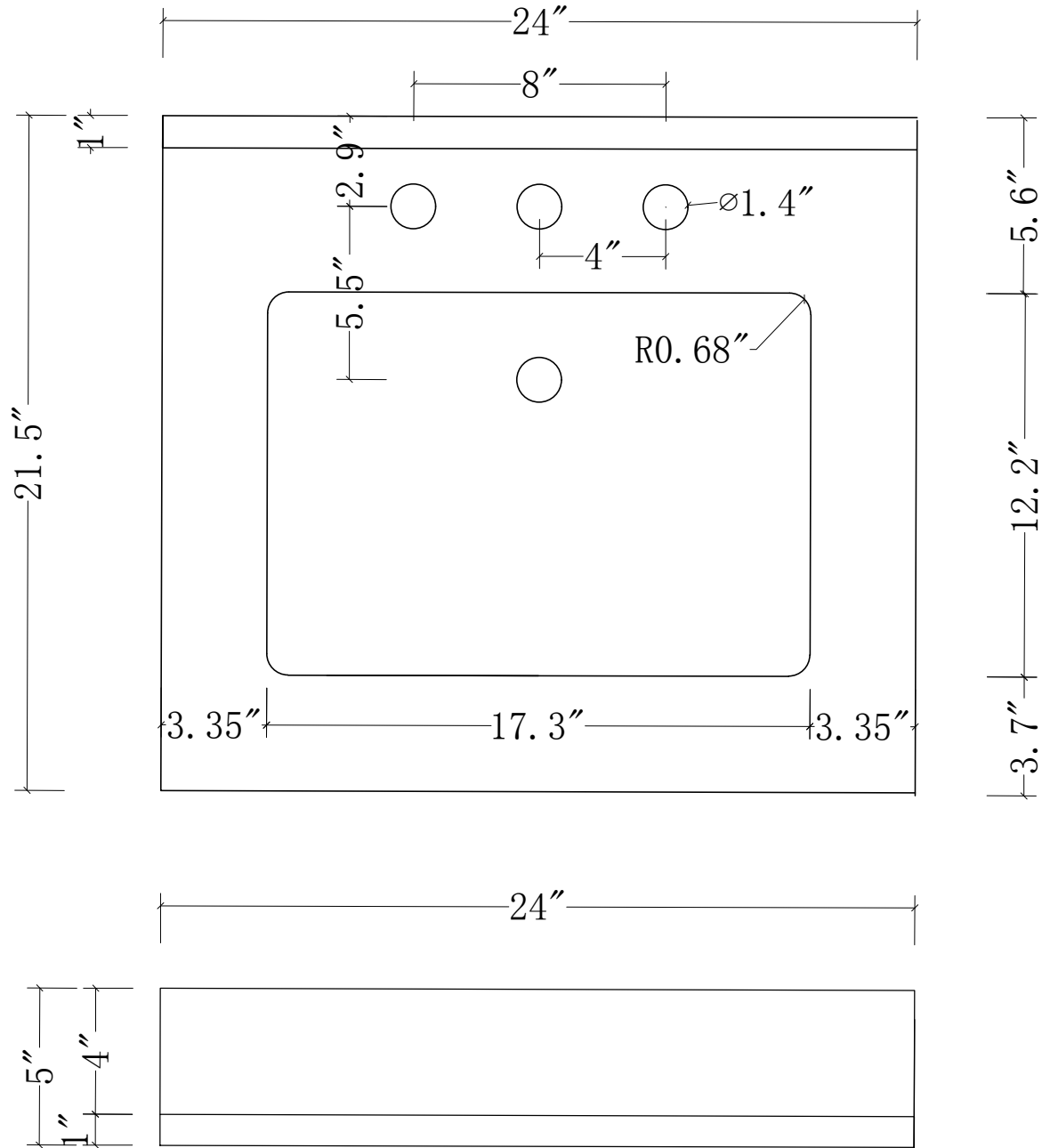



MODEL: MADISON30

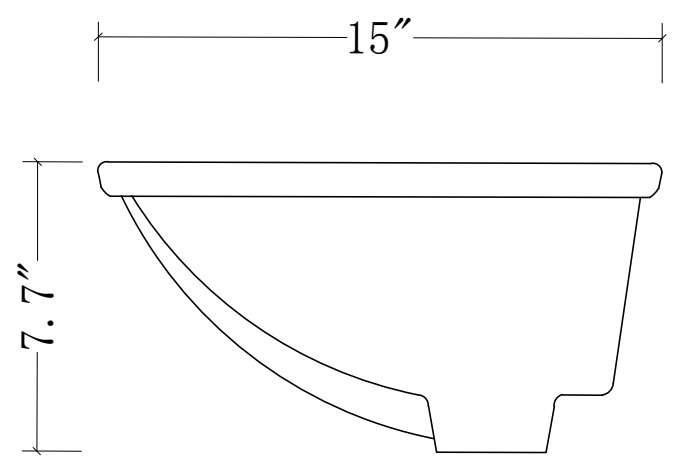
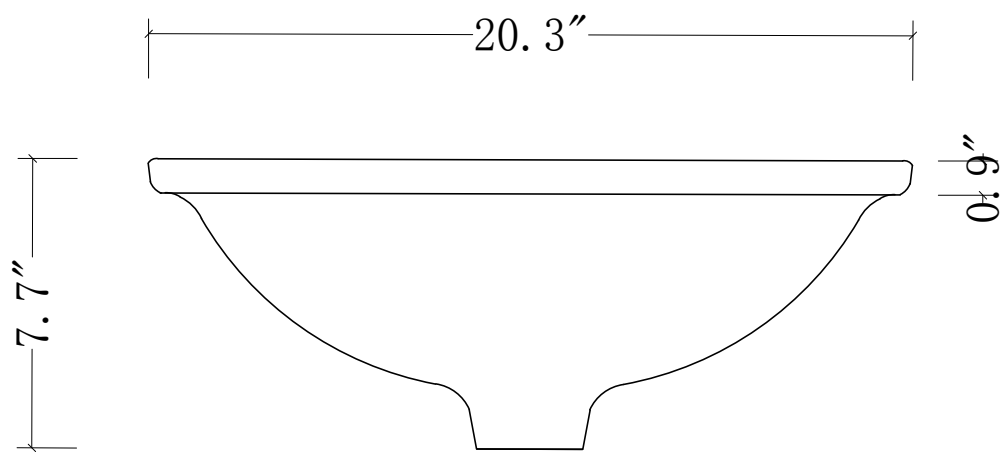
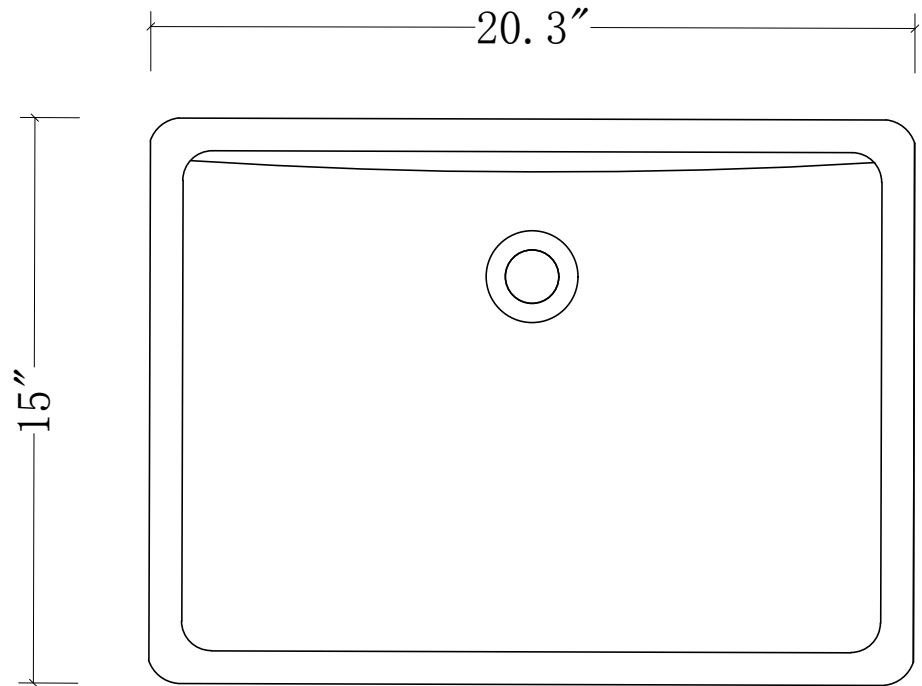



MODEL: RET-M-2136

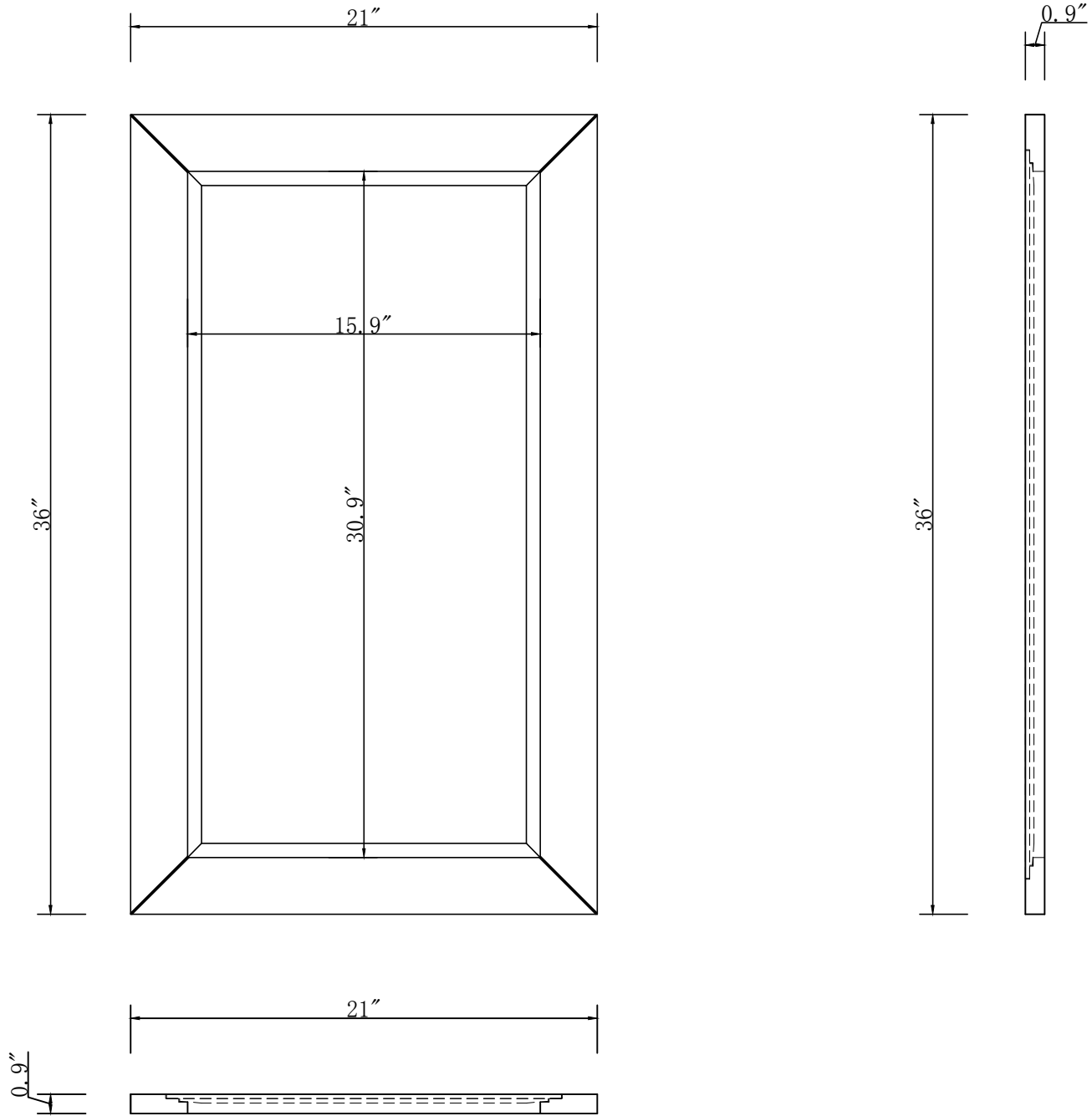



MODEL: F2-0014

